

E8T Assembly Instructions

Please Note: The E8T is designed for one-time installation.

Step 1:

Place the base over the shaft and onto the mounting surface. Slide the centering tool onto the shaft so that it contacts and aligns the base. While applying light pressure to the centering tool, secure the base to the mounting surface using two screws.

Mounting Screws:
2-3 in-lbs torque

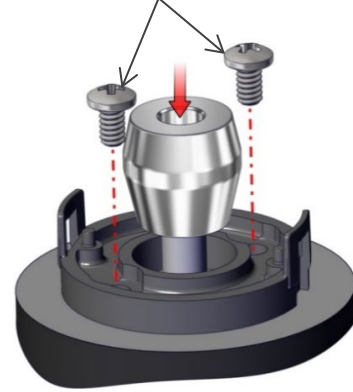

Step 2:

Remove the centering tool. Place the PCB onto the base surface, aligning the board with the two mounting posts. Note that the base is symmetrical allowing the connector to exit out either side.

Caution: To prevent damage, avoid directly touching the optical sensor area when handling the PCB.

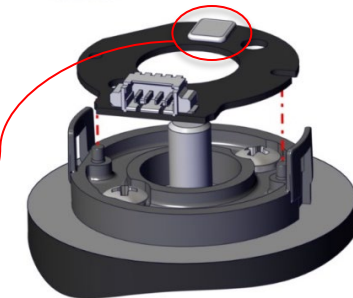

Step 3:

Using the spacer tool, very firmly press down on the PCB in order to push it over the alignment pins and completely onto the base surface. Check to make sure that the PCB is fully seated against the base. If it is not, use the spacer tool to press it again, recheck that it is fully seated.

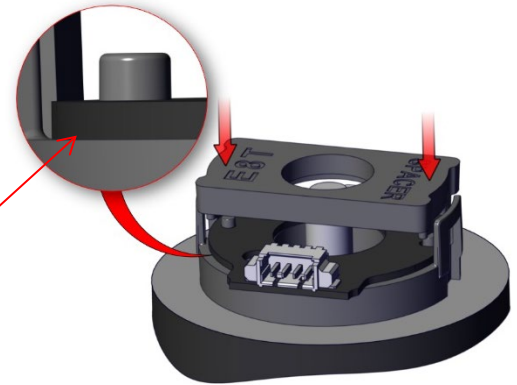

Step 4:

Place the hubdisk onto the shaft with the longer end of hub toward the base. Position the spacer tool onto the hub such that the notches are aligned with the latches of the base. Press down firmly until the tool bottoms out on the PCB. Verify that this action has pressed the PCB flush against the base.

Caution: While installing the hubdisk ensure that the hub bore is parallel to the shaft. Forcing the hub onto the shaft at an angle may cause permanent damage to the hub. Handle disk with care to prevent scratching the disk.

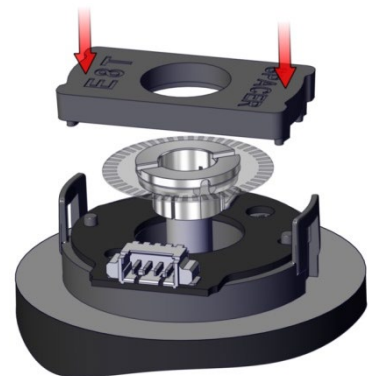

E8T Assembly Instructions

Please Note: The E8T is designed for one-time installation.

Step 5:

Remove the spacer tool and snap the cover down onto the base, (1). With your thumb and finger, squeeze the base latches together to ensure they are fully engaged with the cover, (2).

