

Description

The E2 optical encoder is designed as a direct replacement for the Avago HEDS / HEDM 5500 - 5600 series.

The E2 is a rotary encoder with a rugged glass-filled polymer enclosure, which utilizes either a 5-pin locking or standard connector. The internal components consist of a mylar disk mounted to a precision machined aluminum hub and an encoder module. The module contains a highly collimated solid state light source and monolithic phased array sensor, which together provide a system extremely tolerant to mechanical misalignments.

The E2 is normally designed for applications of 10 feet or less. For longer cable lengths, adding a PC4 / PC5 differential line driver is recommended.

Attachment of the base to a surface may be accomplished by utilizing one of several machine screw bolt circle options. Positioning of the base to the centerline of a shaft is ensured by the use of our centering tool. The cover is securely attached to the base with two 4-40 panhead screws to provide a resilient package protecting the internal components.

Connection to the E2 product is made through either a 5-pin locking or standard connector. The mating connectors are available from US Digital with several cable options and lengths.

Avago Direct Replacements:

US Digital's E2 encoder may now be used as direct replacements for Avago HEDM-5500, HEDM-5600, HEDS-5500, HEDS-5600.

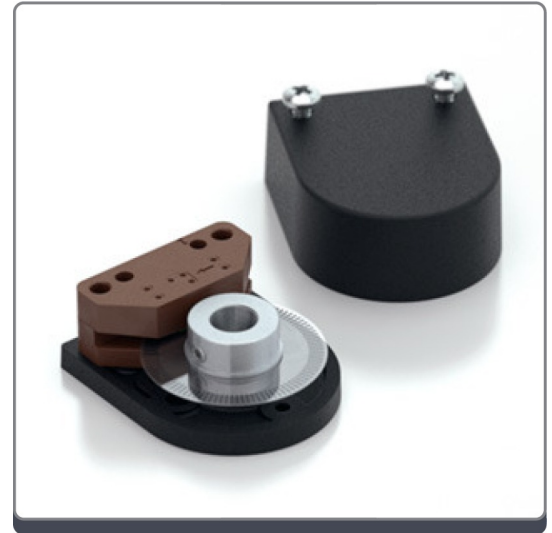

Features

- ▶ Quick, simple assembly and disassembly
- ▶ Rugged screw-together housing
- ▶ Accepts .010" axial shaft play
- ▶ 32 to 5000 cycles per revolution (CPR)
- ▶ 128 to 20000 pulses per revolution (PPR)
- ▶ 2 channel quadrature TTL squarewave outputs
- ▶ Optional index (3rd channel)
- ▶ Mounting compatibility with HEDS-5500

Base & Cover Options

E2 Optical Kit Encoder Base & Cover Options

RELEASE DATE: 04/2/2015

E-OPTION COVER
(EXTENSION FOR LONGER SHAFT LENGTHS)

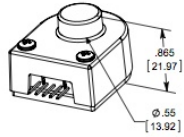

H-OPTION COVER
(COVER HOLE FOR EXTENDED SHAFT LENGTHS)

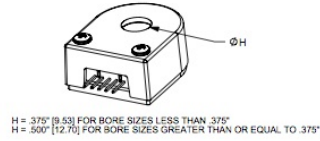

3-OPTION BASE
(LARGER MOUNTING HOLES)

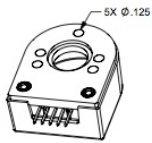

A-OPTION BASE
(ALIGNMENT BOSS)

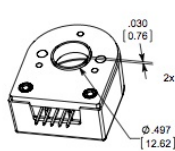

G-OPTION BASE
(1.812" MOUNTING)

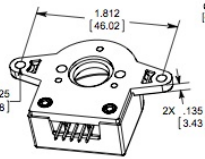

R-OPTION BASE
(ROTATIONAL MOUNTING)

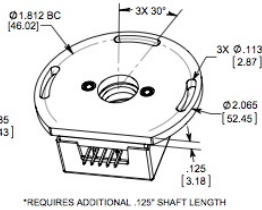

US DIGITAL 1400 NE 136th Avenue
Vancouver, Washington 98684, USA

info@usdigital.com
www.usdigital.com

Local: 360.260.2468
Toll-free: 800.736.0194

UNITS: INCHES (MM)
METRIC SHOWN FOR REFERENCE ONLY

Mechanical Drawing

E2 Optical Kit Encoder Drawing

RELEASE DATE: 11/21/2018

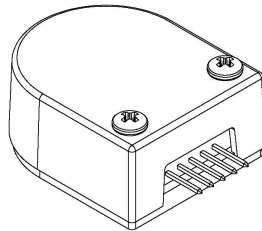
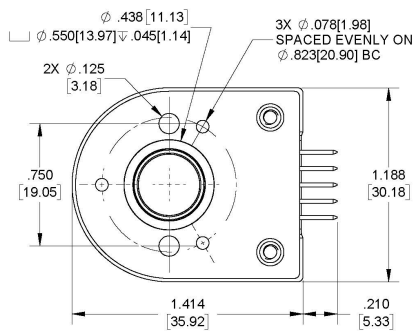
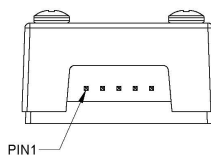
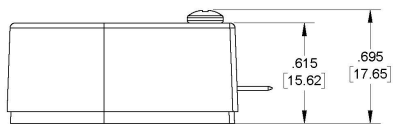

US DIGITAL 1400 NE 136th Avenue
Vancouver, Washington 98684, USA

info@usdigital.com
www.usdigital.com

Local: 360.260.2468
Toll-free: 800.736.0194

UNITS: INCHES (MM)
METRIC SHOWN FOR REFERENCE ONLY

Environmental

Parameter	Value	Units
Operating Temperature, CPR < 2000	-40 to 100	C
Operating Temperature, CPR ≥ 2000	-25 to 100	C
Vibration (5Hz to 2kHz)	20	G
Electrostatic Discharge, IEC 61000-4-2	± 4	kV

Mechanical

Parameter	Value	Units
Max. Shaft Axial Play	±0.010	in.
Max. Shaft Eccentricity Plus Radial Play (1)	0.004	in.
Max. Acceleration	250000	rad/sec ²
For CPR < 2000 Max. RPM (2) (300 kHz) e.x. CPR=1250, max. rpm=14400 e.x. CPR=100, max. rpm=60000	minimum value of ((18 x 10 ⁶) / CPR) and (60000)	RPM
For CPR ≥ 2000 and < 4000 Max. RPM (2) (360 kHz)	minimum value of ((21.6 x 10 ⁶) / CPR) and (60000)	RPM
For CPR ≥ 4000 Max. RPM (2) (720 kHz)	minimum value of ((43.2 x 10 ⁶) / CPR) and (60000)	RPM
Typical Product Weight	0.56	oz.
Codewheel Moment of Inertia	8.0 x 10 ⁻⁶	oz-in-s ²
Hub Set Screw	#4-48	
Hex Wrench Size	0.050	in.
Encoder Base plate Thickness	0.135	in.
3 Mounting Screw Size	#0-80	
2 Mounting Screw Size	#2-56 or #4-40	
3 Screw Bolt Circle Diameter	0.823 ± 0.005	in.
2 Screw Bolt Circle Diameter	0.750 ± 0.005	in.
Required Shaft Length (3)(4) With E-option (4) With H-option	0.445 to 0.575 0.445 to 0.805 > 0.445	in. in. in.
Index Alignment to Hub Set Screw	180 Typical	mechanical degrees
Technical Bulletin TB1001 - Shaft and Bore Tolerances		Download

(1) Position inaccuracy is proportional to shaft radial play.

(2) 60000 rpm is the maximum rpm due to mechanical considerations. The maximum RPM due to the module's maximum frequency response is dependent upon the module's resolution (CPR). For resolutions of 32 to 1999 CPR the frequency response is 300 kHz, 2000 to 3999 CPR the frequency response is 360 kHz and 4000 CPR and greater the frequency response is 720 kHz

(3) Add 0.125" to the required shaft length when using R-option.

(4) Including Axial play.

Torque Specifications

Parameter	Torque
Hub Set Screw to Shaft	2-3 in-lbs
Cover (4-40 screws through cover into base)	2-4 in-lbs
Base to Mounting Surface	4-6 in-lbs
Base to Mounting Adapter Plate	4-6 in-lbs
Adapter Plate to Mounting Surface (4-40 screws)	4-6 in-lbs

Phase Relationship

B leads A for clockwise shaft rotation, and A leads B for counterclockwise rotation viewed from the cover side of the encoder.

Electrical

- › Specifications apply over entire operating temperature range.
- › Typical values are specified at $V_{cc} = 5.0V_{dc}$ and $25^{\circ}C$.
- › For complete details, see the EM1 or EM2 product pages.

Parameter	Min.	Typ.	Max.	Units	Conditions
Supply Voltage	4.5	5.0	5.5	V	
Supply Current		27	33	mA	CPR < 500, no load
		54	62	mA	CPR \geq 500 and <2000, no load
		72	85	mA	CPR \geq 2000, no load
Low-level Output			0.5	V	IOL = 8mA max., CPR < 2000
			0.5	V	IOL = 5mA max., CPR \geq 2000
		0.25		V	no load, CPR \geq 2000
High-level Output	2.0			V	IOH = -8mA max. and CPR < 2000
	2.0			V	IOH = -5mA max. and CPR \geq 2000
		4.8		V	no load and CPR < 2000
		3.5		V	no load and CPR \geq 2000

Parameter	Min.	Typ.	Max.	Units	Conditions
Output Current Per Channel	-8		8	mA	CPR < 2000
	-5		5	mA	CPR ≥ 2000
Output Rise Time		110		nS	CPR < 2000
		50		nS	CPR ≥ 2000, ± 5mA load
Output Fall Time		100		nS	CPR < 2000
		50		nS	CPR ≥ 2000, ± 5mA load

Pin-Out

Pin	Description
1	Ground
2	Index
3	A channel
4	+5VDC power
5	B channel

Note: 5-pin single ended mating connector is CON-C5 or CON-LC5

Accessories

1. Centering Tool

Part #: CTOOL - (Shaft Diameter)

Description: This reusable tool provides a simple method for accurately centering the **E2** base onto the shaft, promoting hub to base concentricity and thus accuracy. It is recommended for the following situations:

- When using mounting screws smaller than #4-40.
- When the position of the mounting holes is in question.
- When using the 3-hole mounting pattern.

2. Hex Tool

Depending on the order packaging option, either a hex driver or hex wrench is included.

Part #: HEXD-050 (only included with **-B** or **-1** packaging options)

Description: Hex driver, 0.050" flat-to-flat for #4-48 set screws.

3. Spacer Tool

A spacer tool is included for all packaging options.

Part #: SPACER-E2

4. Screws

Screws for base mounting must be purchased separately. Screws for mounting the housing to the base are included.

Part #: SCREW-080-250-PH

Description: Pan Head, Philips #0-80 UNF x 1/4"

Quantity Required for Mounting: 3 per encoder

Part #: SCREW-256-250-PH

Description: Pan Head, Philips #2-56 UNC x 1/4"

Quantity Required for Mounting: 2 per encoder

Part #: SCREW-440-250-PH

Description: Pan Head, Philips #4-40 UNC x 1/4"

Quantity Required for Mounting: 2 per encoder

 **Output Waveforms**

SINGLE-ENDED

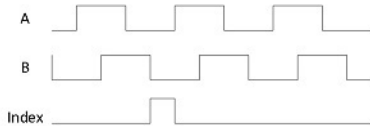

 **Assembly Instructions**

E2 Assembly Instructions - <http://usdigital.com/assets/general/E2%20Assembly%20Instructions.pdf>

 **Ordering Information**

E2 - - - - - -

CPR	Bore	Index	Cover	Base	Packaging
32	079 =	NE =No	D =Default	D =Default	B =Encoder components packaged in bulk.
50	2mm	Index	E =Cover	3 =Base Mounting	One spacer tool, hex tool, and centering tool per 100 encoders.
96	118 =	IE =Index	Extension	Holes become .125"	
100	3mm		H =Hole in	A =Adds self-aligning	1 =Encoders Individually packaged. One
192	125 =1/8"		Cover	shoulder to base	spacer tool, hex tool, and centering tool per 100
200	156 =			G =Adds 1.812	encoders.
250	5/32"			mounting "ears" to	3 =Encoders packaged individually with one
256	157 =			base	spacer tool, one hex wrench, and one centering
360	4mm			R =Adds 3-slot	tool per encoder.
400 =	188 =			adapter to bottom of	
500 =	3/16"			base	
512 =	197 =				
540 =	5mm				
720 =	236 =				
900 =	6mm				
1000 =	250 =1/4"				
1024 =	276 =				
1250 =	7mm				
2000 =	313 =				
2048 =	5/16"				
2500 =	315 =				
4000 =	8mm				
4096 =	375 =3/8"				
5000 =	394 =				
	10mm				

Notes

- US Digital® warrants its products against defects in materials and workmanship for two years. See complete warranty for details.